

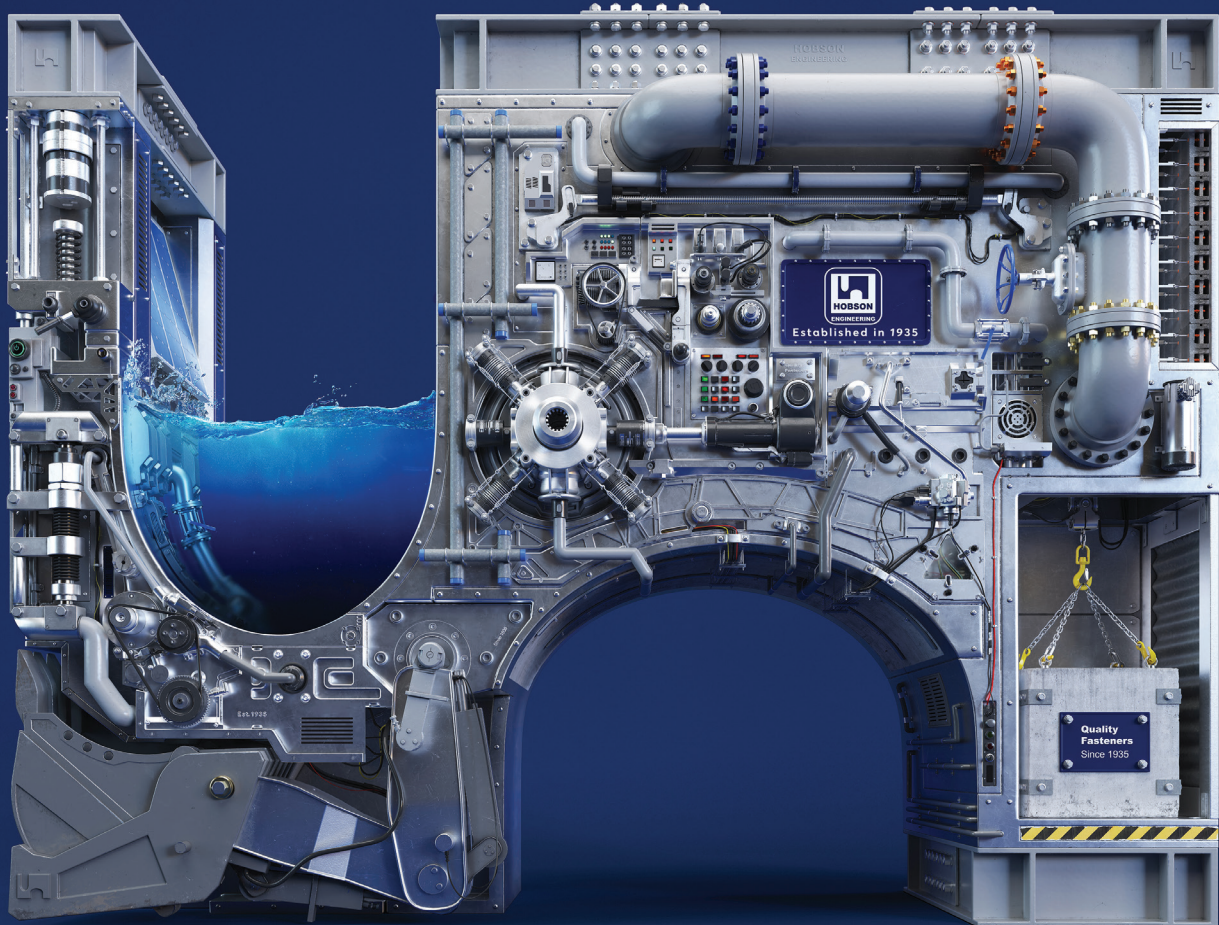

Build **Anything**



| **PRODUCT GUIDE**



DRILLX[®]

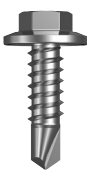
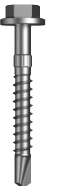

METAL

<p>METAL SDS FLANGED HEX</p>  <p>T9PM3FH</p> <p>CLASS 3 AS3566</p>	<p>METAL SDS FLANGED HEX</p>  <p>T9PMYFH</p> <p>ZYP AS3566</p>	<p>METAL SDS FLANGED HEX</p>  <p>T9PMZFH</p> <p>Z/P AS3566</p>	
<p>METAL SDS FLANGED HEX</p>  <p>T9PM4FH</p> <p>CLASS 4 AS3566</p>	<p>METAL SDS FLANGED HEX 5/16AF</p>  <p>T9PM3RH</p> <p>CLASS 3 AS3566</p>	<p>METAL SDS FLANGED HEX + SEAL WASHER</p>  <p>T9PM4SH</p> <p>CLASS 4 AS3566</p>	<p>EPDM SEAL WASHER FLUTED</p>  <p>TXW9PEFS</p> <p>PLAIN</p>
<p>METAL SDS FLANGED HEX + SEAL WASHER</p>  <p>T9PM4SS</p> <p>CLASS 4 AS3566</p>	<p>METAL SDS FLANGED HEX + SEAL WASHER</p>  <p>T9PM4XS</p> <p>CLASS 4 AS3566</p>	<p>METAL SDS FLANGED HEX + SEAL WASHER</p>  <p>T9PM4XH</p> <p>CLASS 4 AS3566</p>	<p>METAL SDS FLANGED HEX</p>  <p>T9PM4FS</p> <p>CLASS 4 AS3566</p>

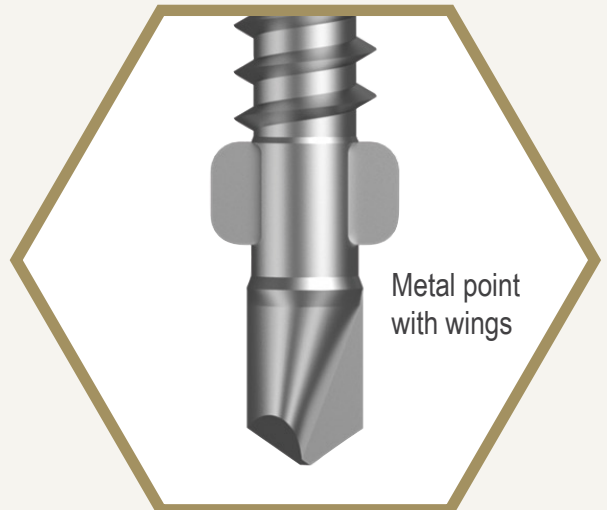



NEW METAL SDS WAFER PHILLIPS



T9PMYWP

ZYP
AS3566

METAL SDS BUGLE BATTEN RIBBED SQUARE

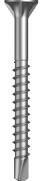

T9PM3BQ

CLASS 3
AS3566

NEW METAL SDS BUGLE PHILLIPS



FLT9PMLBP

B-PH
AS3566

Collated screws



To be used with all auto-feed collated screw guns.

METAL SDS MINI LOW-PROFILE PHILLIPS



T9PM3MP

CLASS 3
AS3566

NEW METAL SDS FLAT SQUARE



T04MSLQ

304
STAINLESS STEEL
USE WITH ALUM

NEW METAL SERRATED FLAT FRAMING PHILLIPS



T9PMKEP

E-COAT
BLACK
AS3566

NEW METAL SUPER FLAT FRAMING PHILLIPS



T9PMKNP

E-COAT
BLACK
AS3566

METAL SDS CSK PHILLIPS



T9PMYCP

ZYP
AS3566

METAL SDS CSK PHILLIPS



T9PM3CP

CLASS 3
AS3566

METAL SDS CSK RIBBED PHILLIPS



T9PMYRP

ZYP
AS3566

METAL SDS CSK RIBBED PHILLIPS



T9PM3RP

CLASS 3
AS3566

METAL SDS PAN PHILLIPS

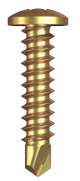

T9PMYPP

ZYP
AS3566

METAL SDS BUGLE PHILLIPS



T9PMYBP

ZYP
AS3566

METAL SDS BUGLE PHILLIPS

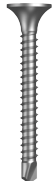

T9PMZBP

Z/P
AS3566

METAL SDS BUGLE BATTEN RIBBED INTERNAL HEX

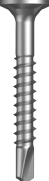

T9PM3BH

CLASS 3
AS3566

METAL SDS WAFER PHILLIPS



T9PM3WP

CLASS 3
AS3566

METAL SDS BUGLE PHILLIPS

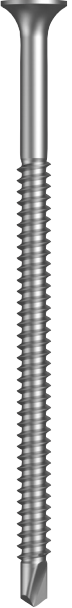

T9PM3BP

CLASS 3
AS3566

METAL SDS BUTTON WAFER PHILLIPS



T9PMYAP

ZYP
AS3566

METAL SDS BUTTON WAFER PHILLIPS



T9PM3AP

CLASS 3
AS3566

METAL SDS FLAT PHILLIPS

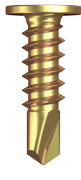

T9PMYLP

ZYP
AS3566

METAL SDS FLAT PHILLIPS

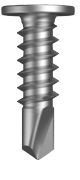

T9PM3LP

CLASS 3
AS3566

METAL SDS FLOWER SELF-EMBED PHILLIPS

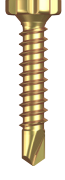

T9PMYOP

ZYP
AS3566

METAL SDS PAN TRILOBULAR

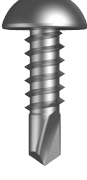

T9PM3PI

CLASS 3
AS3566



METAL

METAL WINGS
FLOWER
SELF-EMBED
SQUARE

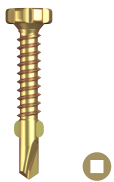

T9PGYOQ

ZYP
AS3566

METAL WINGS
CSK RIBBED
SQUARE



T9PG3RQ

CLASS 3
AS3566

METAL WINGS
CSK
SELF-EMBED
INTERNAL HEX



T9PG3SI

CLASS 3
AS3566

METAL WINGS
CSK RIBBED
SQUARE

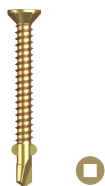

T9PGYRQ

ZYP
AS3566

S500 WINGS
CSK RIBBED
PHILLIPS



T9PHYRP

ZYP
AS3566

S500 SDS
FLANGED HEX

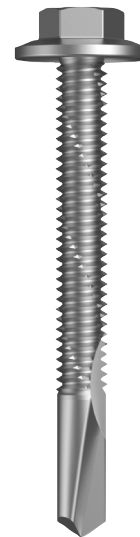

T9P54FH

CLASS 4
AS3566

S500 SDS
FLANGED HEX
+ SEAL WASHER

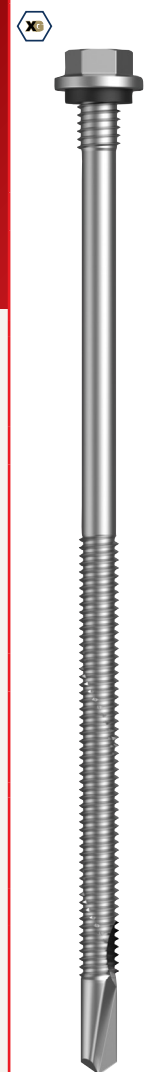

T9P54XH

CLASS 4
AS3566

NEW METAL
SDS HEX POLY
ALL-IN-1



T9PM4PA

CLASS 4
AS3566

Expansion
hole cutter

All in 1 Polycarbonate Roofing Screw



Sealing
washer

S500 SDS
FLANGED HEX
+ SEAL WASHER



T9P54SH

CLASS 4
AS3566

S500 SDS
WAFFER
PHILLIPS



T9P53WP

CLASS 3
AS3566

METAL SDS
CYCLONE
MULTISEAL



T9PM4YM

CLASS 4
AS3566

S500 SDS
CYCLONE
MULTISEAL



T9P54YM

CLASS 4
AS3566

CYCLONE MULTISEAL
WASHER



TXW9PYM

PLAIN
SUIT #14 SCREW

Colorbond®

Cyclone washer is
available in Colorbond®
range of colours p.163

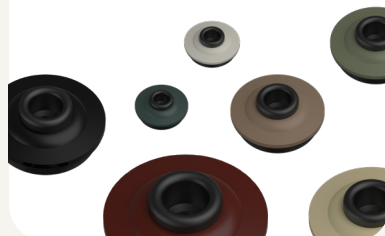



Screw Terminology

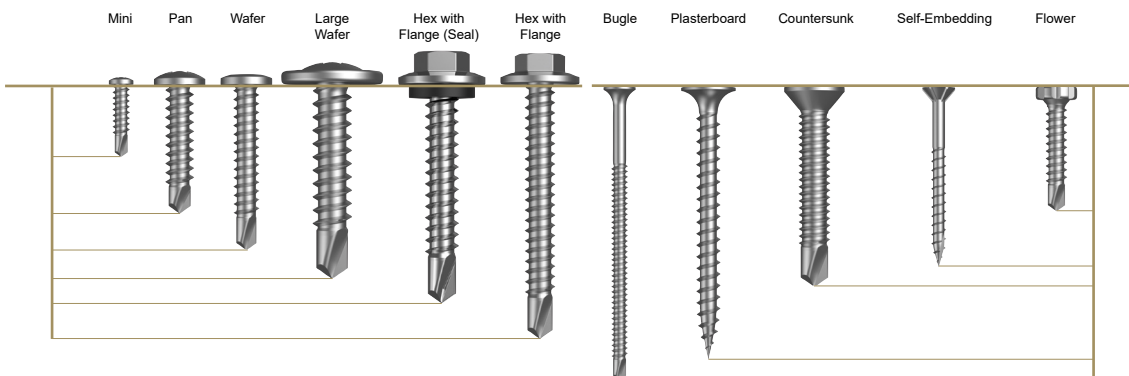
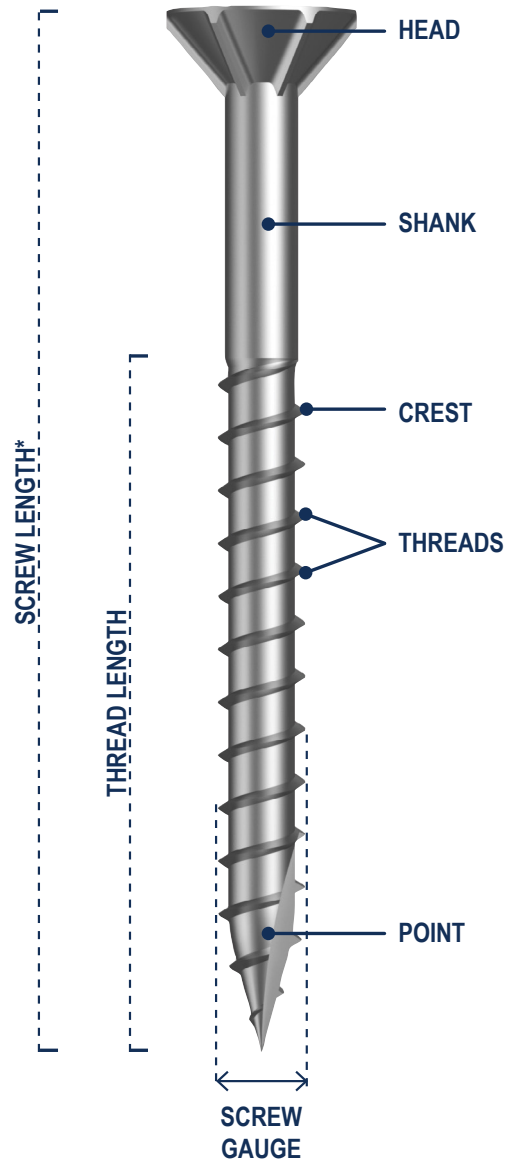

*SCREW TYPES TO MEASURE FROM THE UNDERSIDE OF THE HEAD

*SCREW TYPES TO MEASURE FROM THE TOP OF THE HEAD

KEY

Z/P
ZINC PLATED
(RoHS COMPLIANT)

ZYP
ZINC YELLOW
PASSIVATE

B-PH
BLACK
PHOSPHATE

CL3
CLASS 3

CL4
CLASS 4

R10
R1000 HOURS
PROTECTIVE COAT

ZP BLK
ZINC BLACK
PASSIVATE

TYK
TYKOTE

E-BLK
E-COAT BLACK

PLN
PLAIN

ALLOY
ALLOY STEEL

S2A
S2 ALLOY STEEL

S2B
S2 ALLOY STEEL
BLACK

S2T
S2 ALLOY STEEL
TITAN

ALUM
ALUMINIUM



Bi-FIX®

METAL SDS HEX HEAD

304 **Bi-FIX**



T4XMXHH

BI-METAL
304 STAINLESS STEEL

METAL SDS PAN PHILLIPS

304 **Bi-FIX**



T4XMXPP

BI-METAL
304 STAINLESS STEEL

METAL SDS PAN SQUARE

304 **Bi-FIX**

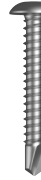

T4XMPQ

BI-METAL
304 STAINLESS STEEL

METAL SDS WAFER PHILLIPS

304 **Bi-FIX**



T4XMXWP

BI-METAL
304 STAINLESS STEEL

METAL WINGS CSK RIBBED SQUARE

304 **Bi-FIX**

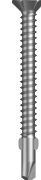

T4XGXRQ

BI-METAL
304 STAINLESS STEEL

S500 WINGS CSK RIBBED SQUARE

304 **Bi-FIX**

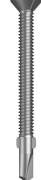

T4XHRQ

BI-METAL
304 STAINLESS STEEL

S500 SDS FLANGED HEX

304 **Bi-FIX**



T4X5XFH

BI-METAL
304 STAINLESS STEEL

METAL SDS ALUMINIUM SEAL HEX

304 **Bi-FIX**



T4XMXAH

BI-METAL
304 STAINLESS STEEL

NEW METAL SDS HEX HEAD

316 **Bi-FIX**



T6MXHH

BI-METAL
316 STAINLESS STEEL

METAL SDS WAFER SQUARE

316 **Bi-FIX**



T6MXWQ

BI-METAL
316 STAINLESS STEEL

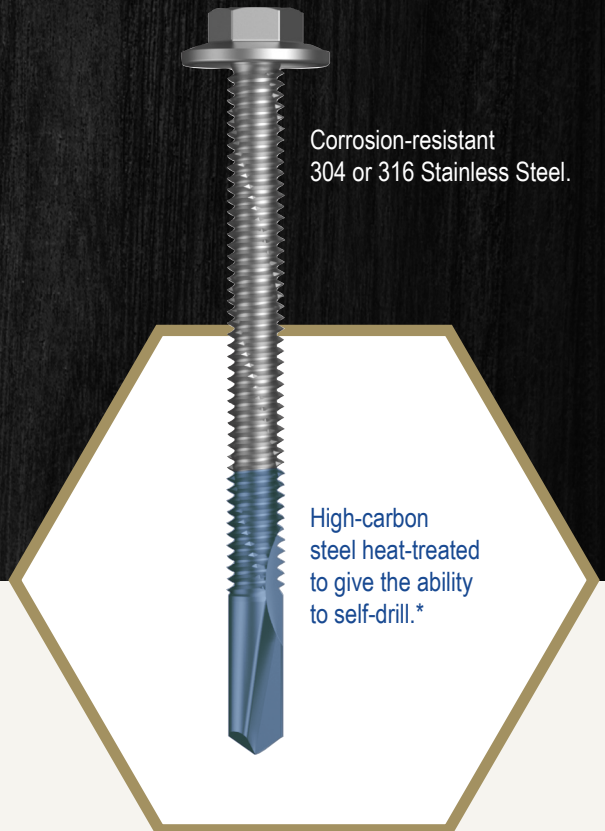

Corrosion-resistant
304 or 316 Stainless Steel.

High-carbon
steel heat-treated
to give the ability
to self-drill.*

*Point colour for illustration purposes only.

A bi-metallic screw is comprised of two metal types. The point is manufactured from high-carbon steel that is heat-treated to give it the ability to self-drill. The head section is made from a corrosion-resistant stainless steel (304 or 316). The two metals are 'fused' to form a screw that offers excellent self-drilling properties, combined with exceptional corrosion resistance.

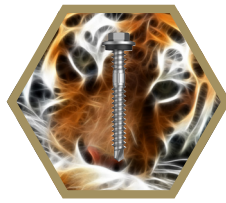

vmaX®

SDS TRIM HEAD TORX

304 vmaX

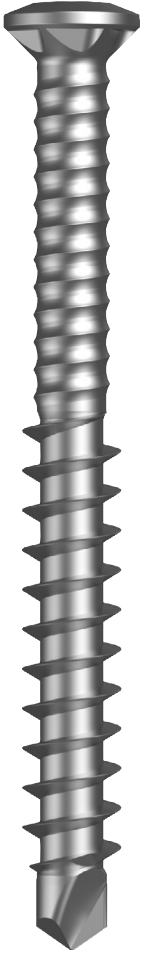

T04VSTT

304 STAINLESS STEEL

SDS FLANGED HEX + SEAL WASHER

vmaX

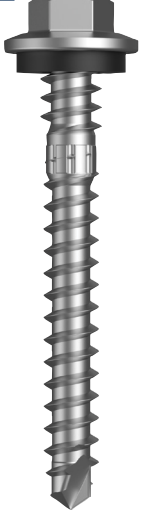

T9PV4XS

CLASS 4 AS3566

SDS BATTEN FLANGED HEX

vmaX



T9PV3FH

CLASS 3 AS3566

SDS FLANGED HEX + SEAL WASHER

vmaX

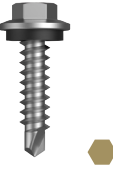

T9PV4SH

CLASS 4 AS3566



vmaX® feature a universal drilling point and are suitable for fastening roof sheeting to thin metal battens, timber trusses and steel purlins up to 1.9mm thick.



TIMBER

<p>TYPE 17 CSK RIBBED SQUARE</p>  <p>T04WS6Q</p> <p>304 STAINLESS STEEL</p>	<p>TYPE 17 BUGLE BATTEN RIBBED INTERNAL HEX</p>  <p>T04WSBH</p> <p>304 STAINLESS STEEL</p>	<p>NEW TYPE 17 PAN POZI</p>  <p>T04WSPZ</p> <p>304 STAINLESS STEEL</p>	<p>NEW TYPE 17 FLANGED HEX 5/16AF PIT SCREW</p>  <p>T04WSRH</p> <p>304 STAINLESS STEEL</p>	<p>TYPE 17 TRIM RIBBED SQUARE</p>  <p>T04WSTQ</p> <p>304 STAINLESS STEEL</p>		
<p>TYPE 17 TRIM RIBBED SQUARE</p>  <p>T04WSTD</p> <p>304 STAINLESS STEEL</p>	<p>TDX®</p> <p>Trim head for a neat finish and No.1 square drive to prevent bit cam out.</p> <p>Square thread for greater holding power, preventing the deck from lifting.</p> 		<p>TYPE 17 BUGLE BATTEN RIBBED INTERNAL HEX</p>  <p>T16WSBH</p> <p>316 STAINLESS STEEL</p>		<p>TYPE 17 BUGLE BATTEN RIBBED SQUARE</p>  <p>T16WSBQ</p> <p>316 STAINLESS STEEL</p>	
<p>TYPE 17 FLANGED HEX</p>  <p>T16WSFH</p> <p>316 STAINLESS STEEL</p>	<p>TYPE 17 FLANGED HEX + SEAL WASHER</p>  <p>T16WSSH</p> <p>316 STAINLESS STEEL</p>	<p>TYPE 17 SELF-EMBED SQUARE</p>  <p>T16WSSQ</p> <p>316 STAINLESS STEEL</p>	<p>TYPE 17 BUTTON SQUARE</p>  <p>T16WSUQ</p> <p>316 STAINLESS STEEL</p>	<p>NEW TYPE 17 WAFFER PHILLIPS</p>  <p>T16WSPW</p> <p>316 STAINLESS STEEL</p>	<p>TYPE 17 BUGLE BATTEN RIBBED INTERNAL HEX</p>  <p>T9PW3BH</p> <p>CLASS 3 AS3566</p>	<p>TYPE 17 CSK PHILLIPS</p>  <p>T9PW3CP</p> <p>CLASS 3 AS3566</p>

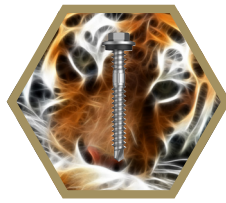

TYPE 17 FLANGED HEX

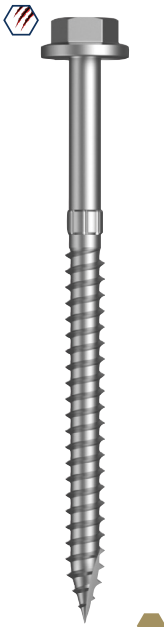

T9PW3FS

CLASS 3
AS3566

Scratchguard®

This design feature improves resistance to corrosion by protecting the fastener shank from severe scratching or scouring, which can occur when fixing metal roofing.

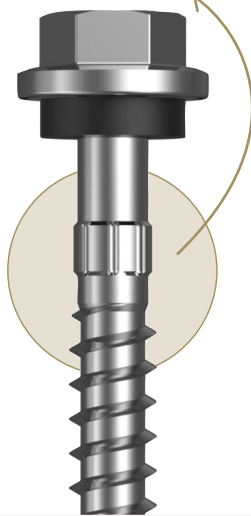

TYPE 17 WASHER HEAD INTERNAL HEX



T9PW3GI

CLASS 3
AS3566

TYPE 17 WAFFER PHILLIPS

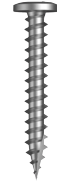

T9PW3WP

CLASS 3
AS3566

NEW TYPE 17 BUGLE BATTEN RIBBED

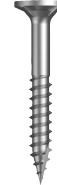

T9PW4BH

CLASS 4
AS3566

TYPE 17 FLANGED HEX

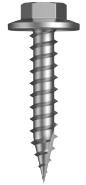

T9PW4FH

CLASS 4
AS3566

TYPE 17 FLANGED HEX

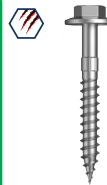

T9PW4FS

CLASS 4
AS3566

NEW TYPE 17 HEX POLY ALL-IN-1



T9PW4PA

CLASS 4
AS3566

TYPE 17 FLANGED HEX + SEAL WASHER

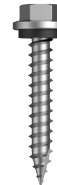

T9PW4SH

CLASS 4
AS3566

TYPE 17 FLANGED HEX + SEAL WASHER

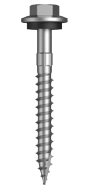

T9PW4SS

CLASS 4
AS3566

TYPE 17 FLANGED HEX + SEAL WASHER

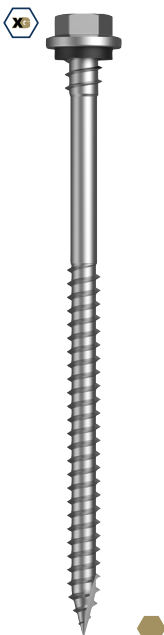

T9PW4XH

CLASS 4
AS3566

XGRIP®

A feature used to hold the roofing tight against the seal, ensuring a watertight seal even when the roof is walked upon.

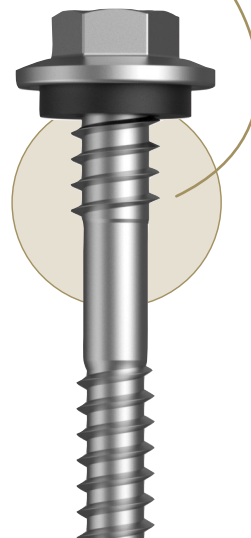

TYPE 17 FLANGED HEX + SEAL WASHER

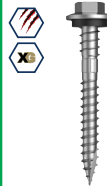

T9PW4XS

CLASS 4
AS3566

TYPE 17 CYCLONE MULTISEAL



T9PW4YM

CLASS 4
AS3566

TYPE 17 WASHER HEAD INTERNAL HEX

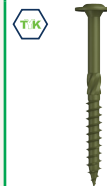

T9PWTGI

TYKOTE
HEC

TYPE 17 WASHER HEAD TORX



T9PWTGO

TYKOTE
HEC

TYPE 17 BUGLE BATTEN RIBBED INTERNAL HEX

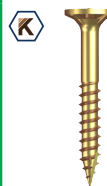

T9PWYBH

ZYP
AS3566

TYPE 17 CSK PHILLIPS



T9PWYCP

ZYP
AS3566

TYPE 17 FLANGED HEX

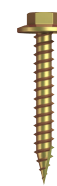

T9PWYFH

ZYP
AS3566

TYPE 17 PAN PHILLIPS

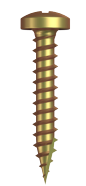

T9PWYPP

ZYP
AS3566



MULTI-USE

NEEDLE POINT CSK RIBBED SQUARE



T04NS4Q

304
STAINLESS STEEL

TREATED PINE SELF-EMBED SQUARE



T9PD3SQ

CLASS 3
AS3566

CHIPBOARD CSK RIBBED PHILLIPS



T9PDYRP

ZYP
AS3566

NEEDLE POINT BUTTON SQUARE



T04NSUQ

304
STAINLESS STEEL

NEW NEEDLE POINT BUGLE PLASTERBOARD PHILLIPS



FLT9PCLBP

B-PH
AS3566
COARSE

Collated screws

To be used with all auto-feed collated screw guns.

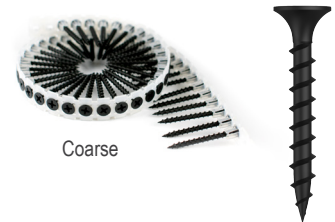

Coarse



Fine

NEEDLE POINT LARGE WAFER METAL STITCH PHILLIPS

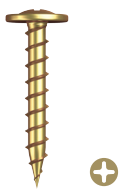

T9PCYAP

ZYP
AS3566
COARSE

NEEDLE POINT BUGLE PLASTERBOARD PHILLIPS

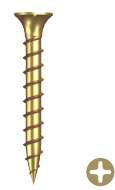

T9PCYBP

ZYP
AS3566
COARSE

NEEDLE POINT LARGE WAFER METAL STITCH PHILLIPS

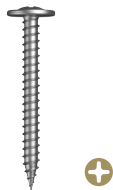

T9PN3AP

CLASS 3
AS3566

TYPE A BUTTON POST TORX

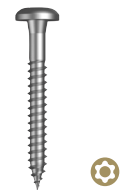

T9PA3BT

CLASS 3
AS3566

NEW NEEDLE POINT BUGLE PLASTERBOARD PHILLIPS



FLT9PNLBP

B-PH
AS3566

NEEDLE POINT FLAT PHILLIPS



T9PN3LP

CLASS 3
AS3566

NEEDLE POINT FLANGED HEX METAL STITCH



T9PN4FH

CLASS 4
AS3566

NEEDLE POINT FLANGED HEX + SEAL WASHER METAL STITCH

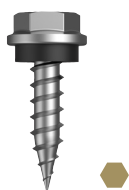

T9PN4SH

CLASS 4
AS3566

NEEDLE POINT LARGE WAFER METAL STITCH PHILLIPS

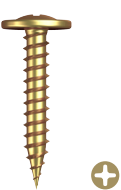

T9PNYAP

ZYP
AS3566

NEEDLE POINT BUGLE PLASTERBOARD PHILLIPS

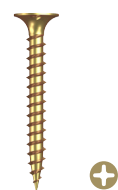

T9PNYBP

ZYP
AS3566

NEEDLE POINT FLAT PHILLIPS



T9PNYLP

ZYP
AS3566

NEEDLE POINT SELF-EMBED PHILLIPS

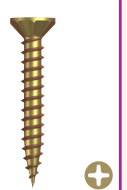

T9PNYSP

ZYP
AS3566



HIGH TENSILE

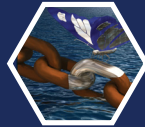

STAINLESS HARDWARE



SCHNORR®



MATERIAL HANDLING



STRUCTURAL



STAINLESS FASTENERS



WASHERS



TRADE PAX™



SOKO®



NEPTUNE®



NYLON®



MUNGO®



EARTHMOVING



BUMAX®



COMMERCIAL



CONXTRACT®



PETRO-CHEMICAL



NORD-LOCK®



LOW TENSILE



DRILLX®



1/26 Ernest Clark Road,
Canning Vale, WA 6155

t. (08) 9457 5444

e. sales@searlefasteners.com.au

searlefasteners.com.au